

Manometri

Nuovi modelli

MANOMETRI



- » Connessioni radiali
- » Connessioni posteriori
- » Fissaggio a pannello

Per una corretta selezione del manometro, il campo di misura deve essere scelto considerando il tipo di applicazione secondo i seguenti criteri:

1. La pressione costante o con lente fluttuazioni deve risultare contenuta entro il 75% del valore di fondo scala.
2. La pressione pulsante o con rapide fluttuazioni deve risultare contenuta entro il 65% del valore di fondo scala.
3. Le isolate punte di pressione non devono mai superare il valore di fondo scala.

Manometro miniaturizzato

Nuovo modello

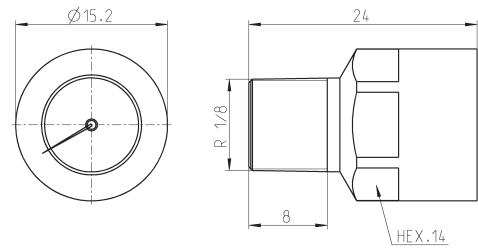

Mod.	Range
M015-P08	0 ÷ 8 bar

Manometri con fissaggio a pannello

Classe di precisione CL1,6

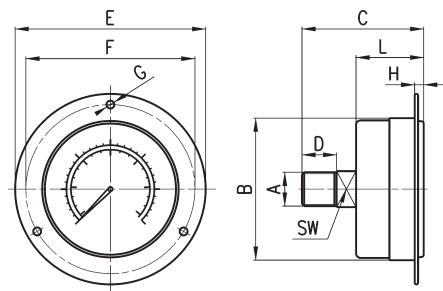

INGOMBRI											
Mod.	A	B	C	D	E	F	G	H	L	SW	Range
M043-F04	R1/8	∅ 40.5	43	10	61	51	∅ 3.5	4	27	12	0-4 bar
M043-F06	R1/8	∅ 40.5	43	10	61	51	∅ 3.5	4	27	12	0-6 bar
M043-F10	R1/8	∅ 40.5	43	10	61	51	∅ 3.5	4	27	12	0-10 bar
M043-F12	R1/8	∅ 40.5	43	10	61	51	∅ 3.5	4	27	12	0-12 bar
M063-F12	R1/4	∅ 63	54	12	85	75	∅ 3.5	4.5	30.5	14	0-12 bar

Manometri con connessione radiale

Classe di precisione CL1,6

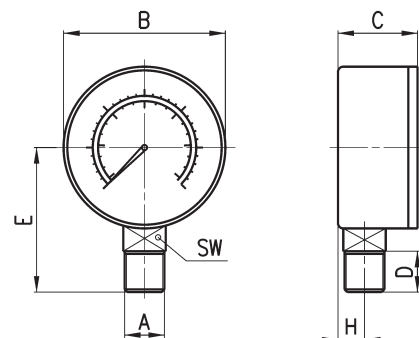

INGOMBRI									
Mod.	A	B	C	D	E	H	SW	Range	
M043-R06	R1/8	∅ 38.8	24.2	10	35.2	9	12	0-6 bar	
M043-R12	R1/8	∅ 38.8	24.2	10	35.2	9	12	0-12 bar	
M053-R12	R1/8	∅ 48.8	27.5	10	43	10	14	0-12 bar	
M063-R12	R1/4	∅ 63	28.8	12	50	10	14	0-12 bar	

Manometri con connessione posteriore

Classe di precisione CL1,6

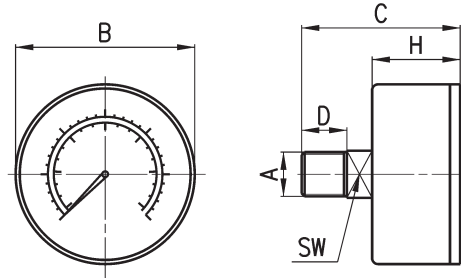

INGOMBRI							
Mod.	A	B	C	D	H	SW	Range
M043-P02,5	R1/8	Ø 38.8	41	10	25	14	0 ÷ 2.5 bar
M043-P04	R1/8	Ø 38.8	41	10	25	14	0 ÷ 4 bar
M043-P06	R1/8	Ø 38.8	41	10	25	14	0 ÷ 6 bar
M043-P10	R1/8	Ø 38.8	41	10	25	14	0 ÷ 10 bar
M043-P12	R1/8	Ø 38.8	41	10	25	14	0 ÷ 12 bar
M053-P04	R1/8	Ø 50	41.5	10	25	14	0 ÷ 4 bar
M053-P06	R1/8	Ø 50	41.5	10	25	14	0 ÷ 6 bar
M053-P10	R1/8	Ø 50	41.5	10	25	14	0 ÷ 10 bar
M053-P12	R1/8	Ø 50	41.5	10	25	14	0 ÷ 12 bar
M063-P04	R1/4	Ø 63	40.5	12	25	14	0 ÷ 4 bar
M063-P06	R1/4	Ø 63	40.5	12	25	14	0 ÷ 6 bar
M063-P12	R1/4	Ø 63	40.5	12	25	14	0 ÷ 12 bar

Manometro incassato

Classe di precisione CL4,0

Il kit comprende:
1 manometro
1 guarnizione
2 viti

Fig. 1 = manometro
Fig. 2 = sede

Nuovo modello

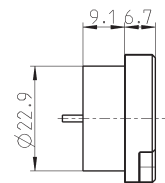
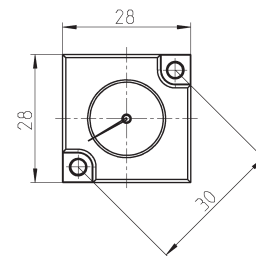

Fig. 1

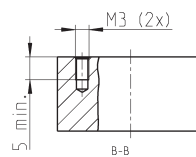
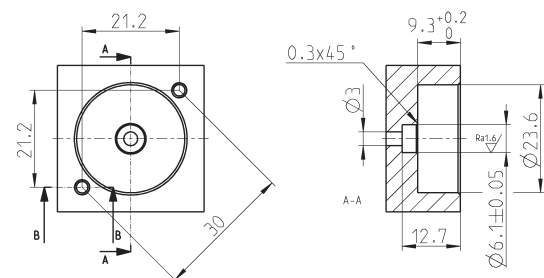

Fig. 2



Mod.	Range
MX3-R30/W-P	0 ÷ 12 bar
MX3-R31/W-P	0 ÷ 6 bar
MX3-R32/W-P	0 ÷ 10 bar
MX3-R33/W-P	0 ÷ 2.5 bar