

# Raccordi e accessori OX1 per applicazioni di gas medicali

Novità

Diametri esterni tubo: 4, 6 e 8 mm

Filetti dei raccordi: metrico (M5), BSP (G1/8, G1/4), BSPT (R1/8, R1/4)

RACCORDI PER OSSIGENO SERIE OX1 IN OTTONE



I raccordi OX1 sono progettati per il settore Life Science, in particolare per applicazioni mediche e analitiche. I produttori di apparecchiature come ventilatori, dispositivi per l'anestesia, concentratori di ossigeno, spettrometria di massa o analizzatori bio-medicali integrano i raccordi della Serie OX1 da molti anni.

Livello di pulizia dei prodotti OX1: Residuo non volatile uguale o inferiore a 550mg/m<sup>2</sup>.  
Livello OX1: pulizia ad ultrasuoni dei componenti, ispezione con luce UV nera, lubrificazione con grasso specifico idoneo ad essere utilizzato con ossigeno.

- » Pulizia ad ultrasuoni
- » Grasso idoneo per uso con ossigeno
- » Sistema di aggancio a pinza per una tenuta ottimale
- » Lunga durata
- » Uso con tubi in PA, PU, PE o Fluoropolimero

#### Raccordi super-rapidi Serie 6000 OX1:

I raccordi super-rapidi della Serie 6000 OX1 sono stati progettati con una pinza speciale che fornisce una tenuta omogenea sull'intera superficie dei tubi in plastica. Grazie a questa particolarità assicurano un'alta affidabilità e una lunga durata, anche se il tubo è stato connesso e disconnesso varie volte.

#### Valvole unidirezionali Serie VNR OX1:

Sono disponibili con Raccordi Push-in integrati. Grazie alla loro costruzione, possono funzionare ad una bassa pressione.

#### Raccordi per tubi in ottone Serie 2000 OX1:

L'ampia gamma di raccordi Camozzi, include modelli dritti, a L e a T, maschio o femmina. garantisce il supporto necessario alla progettazione di sistemi medicali e analitici.

## CARATTERISTICHE GENERALI

<b>Serie 6000</b>	
<b>Diametri</b>	ø 4, 6 e 8mm
<b>Filettature</b>	GAS cilindrico ISO 228 (BSP); M5
<b>Temperatura</b>	-15° C ÷ 80° C (vedere caratteristiche tubi impiegati)
<b>Tubo di collegamento</b>	Poliammide (PA) 6 - 11 - 12, Poliuretano (PU), Fluoropolimero (FEP)
<b>Fluido</b>	Ossigeno, Gas medicali e aria compressa o altri fluidi a bassa pressione
<b>Materiali</b>	- modelli standard: corpo e pinza in OT nichelato, O-ring con FKM con grasso adatto all'ossigeno
<b>Pressione d'esercizio</b>	- modelli standard: -0.9 ÷ 16 bar (vedere tubi)

<b>Serie VNR</b>	
<b>Gruppo Valvola</b>	valvole automatiche
<b>Costruzione</b>	ad otturatore
<b>Materiali</b>	corpo OT molla acciaio INOX guarnizioni FKM
<b>Fissaggio</b>	in qualsiasi posizione
<b>Attacchi</b>	Ø4; Ø6; Ø8
<b>Temperatura d'esercizio</b>	0 °C ÷ 80 °C
<b>Fluido</b>	Ossigeno, Gas medicali e aria compressa o altri fluidi a bassa pressione

<b>Serie 2000</b>	
<b>Filettature</b>	GAS conico ISO 7 (BSPT) GAS cilindrico ISO 228 (BSP)
<b>Temperatura</b>	-40 °C ÷ 120 °C
<b>Fluido</b>	Ossigeno, Gas medicali e aria compressa o altri fluidi a bassa pressione
<b>Materiali</b>	OT nichelato
<b>Pressione di esercizio</b>	80 bar

**Raccordi Mod. 6512-OX1**

**Novità**

Diritto Maschio Metrico-Cilindrico

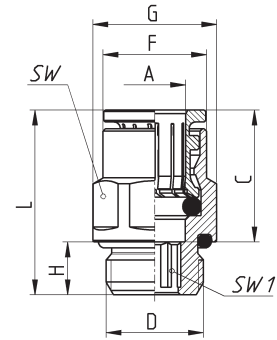

DIMENSIONI										
Mod.	A	D	C	F	G	H	L	SW	SW1	Peso (g)
6512 4-M5-OX1	4	M5	14.0	7.8	8.8	4	20	8	2	4
6512 4-1/8-OX1	4	G1/8	14.0	8.8	13.5	6	19	12	2.5	10
6512 6-M5-OX1	6	M5	16.0	11.7	13.2	4	22	12	2	8
6512 6-1/8-OX1	6	G1/8	16.0	11.7	13.5	6	21	12	4	10
6512 6-1/4-OX1	6	G1/4	16.0	11.7	16.4	7	22	15	4	13
6512 8-1/8-OX1	8	G1/8	17.5	13.7	15.2	6	26	14	5	15
6512 8-1/4-OX1	8	G1/4	17.5	13.7	16.4	7	24.5	15	6	17

**Raccordi Mod. 6700-OX1**

**Novità**

Cartuccia

S\* = sia per sede metallica  
che per sede sintetica

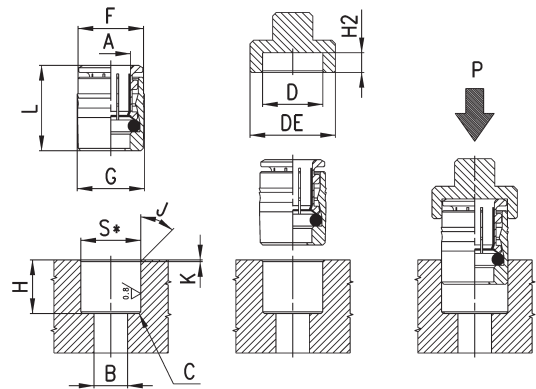

Mod.	A	B	C	D	DE	F	G	H	H2	J	K	L	P min	P max	S (+0,01/-0,04)	Peso (g)
6700 4-OX1	4	3.5	0.5x45°	8.8	14	8.6	9	11	3.3	15°	0.5	14.5	200	360	8.75	4
6700 6-OX1	6	4	0.5x45°	12	17	11.8	12.2	12	3.8	15°	0.5	16.5	160	570	11.95	8

**Raccordi Mod. 6463-OX1**

**Novità**

Diritto Femmina Metrico-Cilindrico

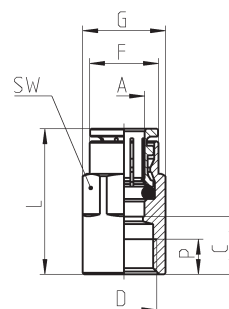

DIMENSIONI									
Mod.	A	D	C	F	G	L	P (min)	SW	Peso (g)
6463 4-1/8-OX1	4	G1/8	10	9	13	24	6	12	14
6463 6-1/8-OX1	6	G1/8	10	11.7	13	26	6	12	14
6463 6-1/4-OX1	6	G1/4	11.5	11.9	16.5	27.5	7	15	23

RACCORDI PER OSSIGENO SERIE OX1 IN OTTONE

**Raccordi Mod. 6522-OX1**

**Novità**

Gomito Maschio Girevole  
Metrico-Cilindrico

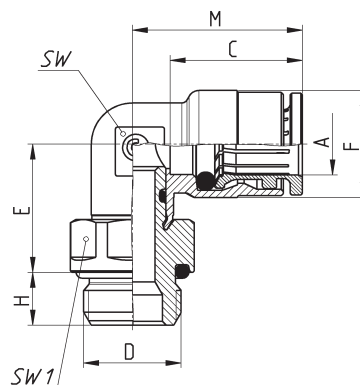

DIMENSIONI										
Mod.	A	D	C	E	F	H	M	SW	SW1	Peso (g)
6522 4-M5-OX1	4	M5	14.0	12.5	9	4	17.5	8	8	12
6522 4-1/8-OX1	4	G1/8	14.0	14.5	9	6	17.5	8	12	15
6522 6-M5-OX1	6	M5	16.0	13	12.7	4	20	9	10	14
6522 6-1/8-OX1	6	G1/8	16.0	15	12.7	6	20	9	12	19
6522 6-1/4-OX1	6	G1/4	16.0	16	12.7	7	20	9	15	27
6522 8-1/8-OX1	8	G1/8	17.5	16	14.2	6	22.5	11	12	22
6522 8-1/4-OX1	8	G1/4	17.5	17	14.2	7	22.5	11	15	28

**Raccordi Mod. 6590-OX1**

**Novità**

Passaparete

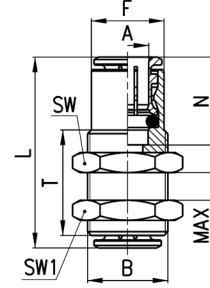

DIMENSIONI										
Mod.	A	B	F	L	N	MAX	SW	SW1	T	Peso (g)
6590 4-OX1	4	M10x1	8.8	29	14	10.5	14	14	20	16
6590 6-OX1	6	M14x1	12.5	33	16	10.5	17	17	20	28

**Raccordi Mod. 6580-OX1**

**Novità**

Diritto Intermedio

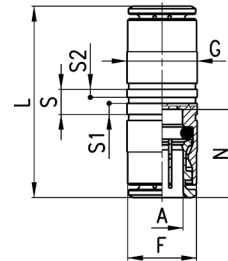

DIMENSIONI									
Mod.	A	F	G	L	N	S	S1	S2	Peso (g)
6580 4-OX1	4	8.4	9	29	14	5	2.2	1.6	11
6580 6-OX1	6	11.7	12	34	16	5	2.2	1.6	16
6580 8-OX1	8	13.7	14	37	17.5	5	2.2	1.6	23

**Raccordi Mod. 6550-OX1**

**Novità**

Gomito Intermedio

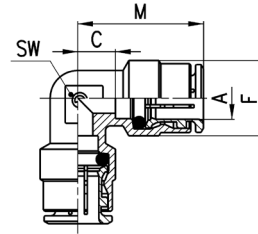

DIMENSIONI						
Mod.	A	C	F	M	SW	Peso (g)
6550 4-OX1	4	3.5	9	17.5	8	8
6550 6-OX1	6	4	12.7	20	9	17

**Raccordi Mod. 6540-OX1**

**Novità**

T Intermedio

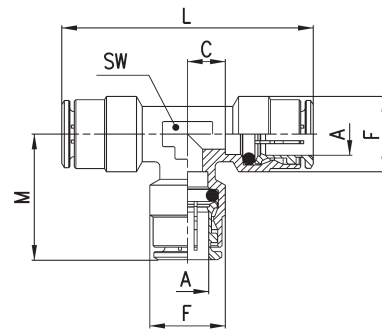

DIMENSIONI							
Mod.	A	C	F	L	M	SW	Peso (g)
6540 4-OX1	4	3.5	9	35	17.5	8	14
6540 6-OX1	6	4	12.7	40	20	9	24

**Raccordi Mod. 6560-OX1**

**Novità**

Y Intermedio

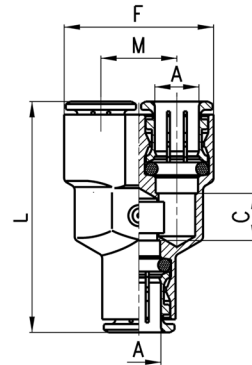

DIMENSIONI						
Mod.	A	C	F	L	M	Peso (g)
6560 4-OX1	4	5	18	33	9	19
6560 6-OX1	6	7	24.5	39	12.5	30

**Raccordi Mod. 6750-OX1**

**Novità**

Tappo femmina

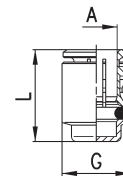

DIMENSIONI				
Mod.	A	G	L	Peso (g)
6750 4-OX1	4	8.8	15	4
6750 6-OX1	6	11.8	17	7

RACCORDI PER OSSIGENO SERIE OX1 IN OTTONE

**Raccordi Mod. 6800-OX1**

**Novità**



Riduzione

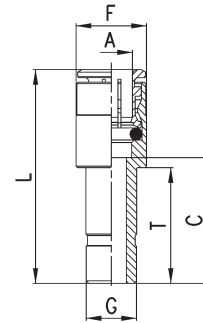

DIMENSIONI							
Mod.	A	G	C	F	L	T	Peso (g)
6800 4-6-OX1	4	6	15.5	9	29.5	18	9
6800 4-8-OX1	4	8	18	9	32	20.5	10
6800 6-8-OX1	6	8	18	12.7	34	20.5	12

**Raccordi Mod. 6555-OX1**

**Novità**



Gomito con Codolo Innestabile

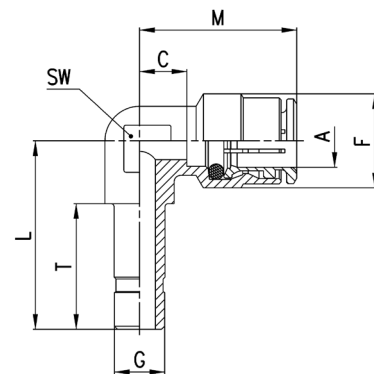

DIMENSIONI									
Mod.	A	G	C	L	F	T	M	SW	Peso (g)
6555 6-6-OX1	6	6	4	24.5	12.7	18	20	9	14



**Accessorio Mod. 6900-OX1**

**Novità**



Tappo Maschio in plastica

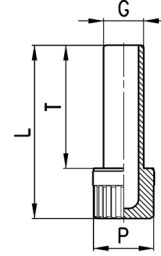

DIMENSIONI					
Mod.	G	L	P	T	Peso (g)
6900 4-OX1	4	29	8	20	1
6900 6-OX1	6	31.5	8	22.5	1

**Valvole unidirezionali Serie VNR**

**Novità**

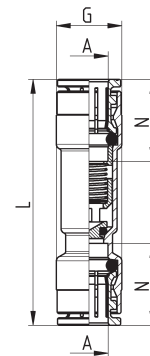

Mod.	A	G	L	N	Portata 6bar ΔP1(Nl/min)	Pressione min. d'azionamento (bar)	Pressione max d'esercizio (bar)	Peso (g)
6580 4-VNR-OX1	4	9	40	14	85	0,2	10	13
6580 6-VNR-OX1	6	12	48	16	450	0,2	10	20
6580 8-VNR-OX1	8	14	52.5	17.5	900	0,2	10	30

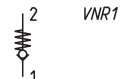

**Raccordi Mod. 2500-OX1**

**Novità**



Nipplo Conico

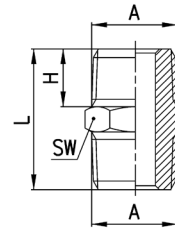

DIMENSIONI					
Mod.	A	H	L	SW	Peso (g)
2500 1/8-OX1	R1/8	7,5	19,5	12	9
2500 1/4-OX1	R1/4	11	27	14	16

**Raccordi Mod. 2501-OX1**

**Novità**



Nipplo Metrico-Cilindrico

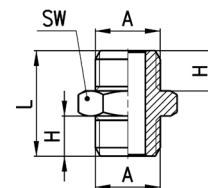

DIMENSIONI					
Mod.	A	H	L	SW	Peso (g)
2501 1/8-OX1	G1/8	6	16,5	13	9
2501 1/4-OX1	G1/4	8	21	17	15

**Raccordi Mod. 2510-OX1**

**Novità**

Nipplo Ridotto Conico

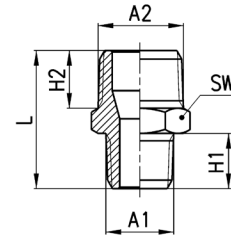

RACCORDI PER OSSIGENO SERIE OX1 IN OTTONE

DIMENSIONI							
Mod.	A1	A2	H2	H1	L	SW	Peso (g)
2510 1/8-1/4-OX1	R1/8	R1/4	11	7,5	23,5	14	14

**Raccordi Mod. 2531-OX1**

**Novità**

Riduzione Cilindrica

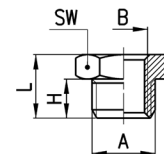

DIMENSIONI						
Mod.	A	B	H	L	SW	Peso (g)
2531 1/8-M5-OX1	G1/8	M5	6	10,5	13	8 *
2531 1/4-1/8-OX1	G1/4	G1/8	8	13	17	11 *

\* = con filetto passante

**Raccordi Mod. 2543-OX1**

**Novità**

Manicotto

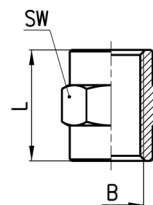

DIMENSIONI				
Mod.	B	L	SW	Peso (g)
2543 M5-OX1	M5	11	8	3
2543 1/8-OX1	G1/8	15	13	8
2543 1/4-OX1	G1/4	22	17	19

**Raccordi Mod. 2611-OX1**

**Novità**

Tappo Maschio Cilindrico

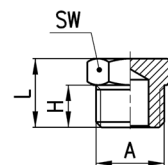

DIMENSIONI					
Mod.	A	H	L	SW	Peso (g)
2611 M5-OX1	M5	4	7,5	8	2
2611 1/8-OX1	G1/8	6	10,5	13	7
2611 1/4-OX1	G1/4	8	13	17	13

**Raccordi Mod. 2013-OX1**

**Novità**

Gomito Femmina Cilindrico

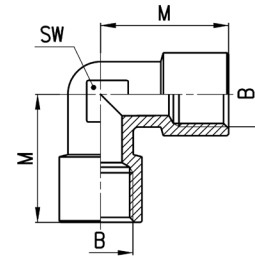

DIMENSIONI				
Mod.	B	M	SW	Peso (g)
2013 1/8-OX1	G1/8	19	11	16
2013 1/4-OX1	G1/4	23	14	28

**Raccordi Mod. 2021-OX1 e Mod. 2020-OX1**

**Novità**

Mod. 2021-OX1: Gomito Maschio Femmina Metrico  
Mod. 2020-OX1: Gomito Maschio Femmina Conico

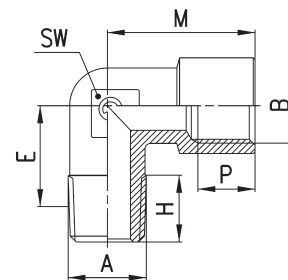

DIMENSIONI								
Mod.	A	B	E	H	M	P (min)	SW	Peso (g)
2020 1/8-1/8-OX1	R1/8	G1/8	11,5	8,5	19	6	11	17
2020 1/4-1/4-OX1	R1/4	G1/4	15	11	23	7	13	27

**Raccordi Mod. 2003-OX1**

**Novità**

T Femmina

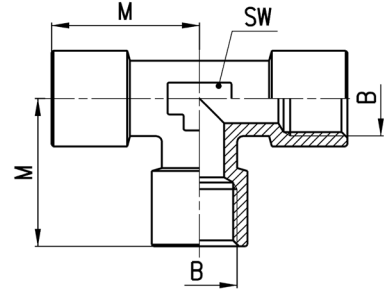

DIMENSIONI				
Mod.	B	M	SW	Peso (g)
2003 1/8-OX1	G1/8	19	12	23
2003 1/4-OX1	G1/4	23	13	39

**Raccordi Mod. 2043-OX1**

**Novità**

Y Femmina

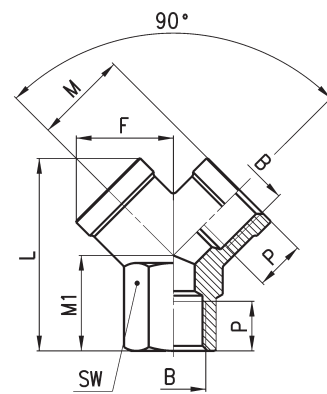

DIMENSIONI								
Mod.	B	F	L	M	M1	P	SW	Peso (g)
2043 1/8-OX1	G1/8	14,5	26,5	14	12	8	13	18
2043 1/4-OX1	G1/4	18	32	17,5	14	11	17	32